

COOLING SYSTEM

OUTLINE	3-2
SPECIFICATIONS	3-2
TROUBLESHOOTING GUIDE	3-2
COOLANT	3-3
CHECKING COOLANT LEVEL	3-3
REPLACEMENT	3-3
ANTI-FREEZE SOLUTION	3-3
FAN BELT	3-3
FAN DRIVE	3-4
CHECKING FAN DRIVE	3-4
REPLACING FAN DRIVE CLUTCH	3-4
THERMOSTAT	3-4
REMOVING THERMOSTAT	3-4
CHECKING THERMOSTAT	3-4
INSTALLING THERMOSTAT	3-5
RADIATOR CAP	3-5
CHECKING RADIATOR CAP	3-5
RADIATOR	3-5
CHECKING RADIATOR	3-5
REMOVING RADIATOR	3-6
INSTALLING RADIATOR	3-6
WATER PUMP	3-6
CHECKING WATER PUMP	3-6
REMOVING WATER PUMP	3-7
DISASSEMBLING WATER PUMP	3-7
INSPECTING WATER PUMP	3-8
ASSEMBLING WATER PUMP	3-8
INSTALLING WATER PUMP	3-9

3 OUTLINE, TROUBLESHOOTING GUIDE

OUTLINE

SPECIFICATIONS

System		Water-cooled, forced circulation
Coolant quantity		9.5 liters (10.0 U.S. quarts, 8.4 Imp. quarts)
Thermostat	Type	Wax type
	Initial opening temperature	80.5 ~ 83.5°C (197 ~ 183°F)
	Full-open temperature	95°C (203°F)
	Full-open lift	8 mm (0.315 in) or more
Water pump	Type	Centrifugal
Radiator	Type	Corrugated-fin type
	Cap valve pressure	75 ~ 105 kPa (11 ~ 15 lb/in ²)
Cooling fan	Outer diameter x quantity	390 mm (15.4 in) x 8
Fan drive	Type	Thermo-modulated

47U030-502

TROUBLESHOOTING GUIDE

Problem	Probable Cause	Remedy	Page
Coolant leakage	Damaged radiator core seam	Replace	3-4
	Leakage from radiator hose or heater hose	Repair or replace	3-4
	Leakage from water temperature switch	Replace	—
	Malfunction of water seal	Replace	3-7
	Loose or damaged thermostat cover or thermostat case	Repair or replace	3-3
	Loose tension bolt	Tighten	Refer to Section 1
	Damaged sealing rubber	Replace	Refer to Section 1
	Cracked side housing	Replace	Refer to Section 1
Corrosion	Cracked rotor housing	Replace	Refer to Section 1
	Impurities in water	Clean	3-2
Overheating	Clogged water passage	Clean	—
	Malfunction of thermostat	Replace	3-3
	Clogged radiator fins	Clean	3-4
	Malfunction of water pump	Repair or replace	3-5
	Loose or broken fan belt	Adjust or replace	3-2
	Insufficient coolant	Add water	3-2

57U030-602

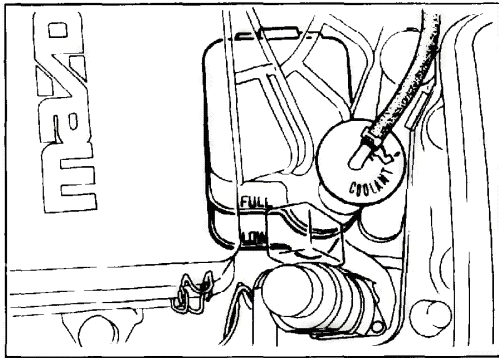

47U030-001

COOLANT

CHECKING COOLANT LEVEL

With coolant cold, check whether the coolant level is near the inlet port, and whether the level in the reserve tank is between the FULL and LOW marks. Add coolant if the level is low.

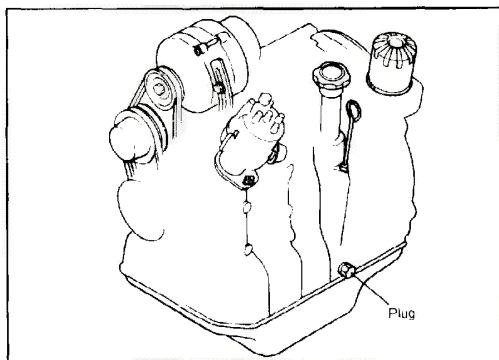

47U030-002

REPLACEMENT

1. Drain coolant out after opening the intermediate side housing plug.
2. Close and tighten the plug.
3. After pouring anti-freeze into the radiator according to the instruction below, add soft water.
4. Start the engine, bleed air from the coolant passages, and then add more coolant.

ANTI-FREEZE SOLUTION

Use recommended mixture of 50% ethylene glycol anti-freeze solution for aluminum engine and 50% clean soft water (demineralized water).

For proper system protection in regions where the temperature goes below -29°C (-20°F), add the necessary amount of ethylene glycol base coolant recommended by the coolant manufacturer.

47U030-603

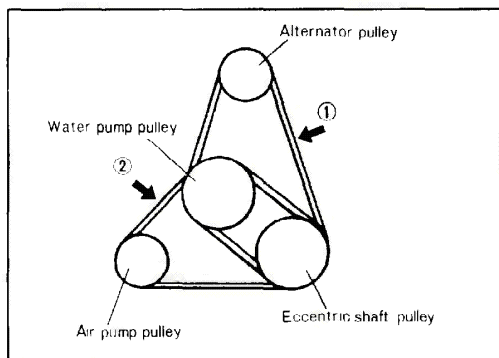

57U030-003

FAN BELT

INSPECTION AND ADJUSTMENT

1. Completely check all surfaces of the fan belt. Replace it if it is cracked or damaged.
2. Check the amount of deflection (at a point half-way between the alternator pulley and the eccentric shaft pulley) by applying a pressure of about 10 kg (22 lb).

Deflection:

1. 13 ~ 17 mm (0.51 ~ 0.67 in)
2. 11 ~ 13 mm (0.43 ~ 0.51 in)

3 FAN DRIVE, THERMOSTAT

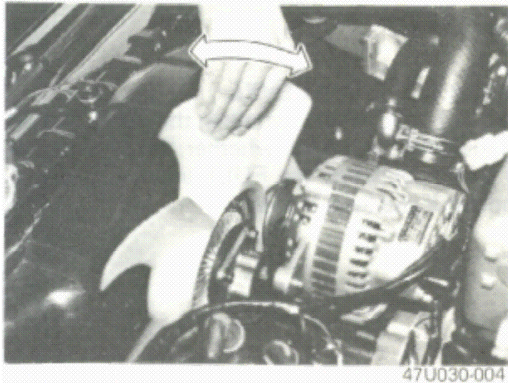

FAN DRIVE

CHECKING FAN DRIVE

Check the following items and, if necessary, replace the part.

1. When the engine is cold, turn the cooling fan by hand and check to be sure that resistance is felt.
2. Check to be sure that there is no fluid leakage from the fan drive clutch.
3. Check to be sure that there is no deformation of the bimetal.
4. Check to be sure that there is no bearing play or grease leakage.

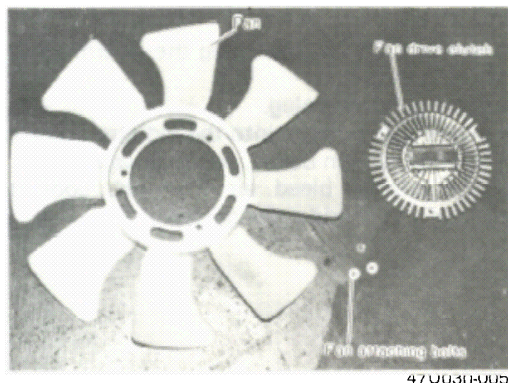

REPLACING FAN DRIVE CLUTCH

1. Remove the fan and fan drive assembly.
2. Remove the fan attaching bolts and separate the fan from the fan drive.
3. Assemble the fan and fan drive, and install them in the reverse order of removal.

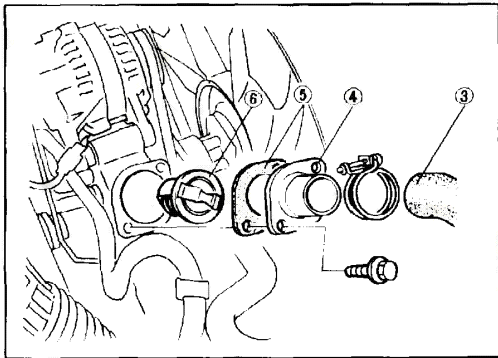

THERMOSTAT

REMOVING THERMOSTAT

1. Drain the cooling system by disconnecting the radiator lower hose.
2. Remove the air cleaner (12A).
3. Disconnect the radiator upper hose.
4. Remove the thermostat cover.
5. Remove the gasket.
6. Lift out the thermostat.

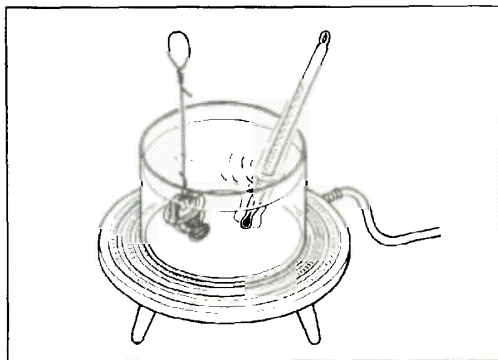

CHECKING THERMOSTAT

1. Place the thermostat in water with a thermometer and heat the water gradually.
2. Check the temperature when the thermostat starts to open and when it opens fully. Also, measure the lift height when the thermostat is fully opened.

Specifications:

Starts to open: 80.5 ~ 83.5°C
(177.3 ~ 182.7°F)

Fully opens at: 95°C (203°F)

Lift: 8 ~ 10 mm (0.3 ~ 0.4 in)

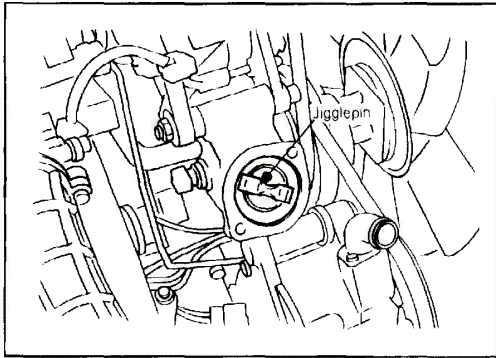

47U030-008

INSTALLING THERMOSTAT

1. Install the thermostat.

Note

Install the thermostat so that the jiggle pin is positioned on the upper side; if it is not, the valve-opening temperature will change.

2. Attach the thermostat cover.
3. Connect the radiator upper hose.
4. Install the air cleaner (12A engine).
5. Connect the radiator lower hose.
6. Fill the radiator with engine coolant.

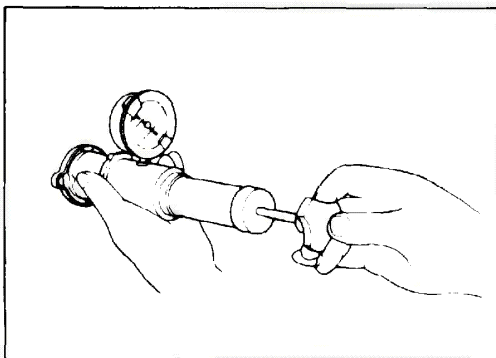

47U030-009

RADIATOR CAP

CHECKING RADIATOR CAP

1. Attach the radiator cap to a tester. Apply pressure gradually, and then check to be sure that the pressure is uniform within the range of **75 ~ 105 kPa (11 ~ 15 lb/in²)**.
2. Wait about 10 seconds, and then check whether the pressure has decreased.

Note

Replace the cap if the pressure doesn't reach **75 kPa (11 lb/in²)**, or if it exceeds **105 kPa (15 lb/in²)**.

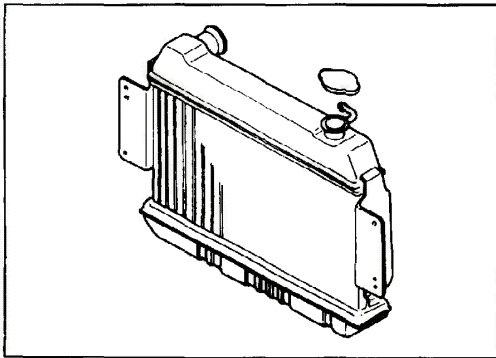

57U030-010

RADIATOR

CHECKING RADIATOR

1. Examine the radiator carefully for leaks. If a leak is discovered, however small it may be, repair completely by soldering, or replace.
2. Clean the exterior of the radiator core by blowing with compressed air.
3. Check the pressure cap rubber gasket. Replace the pressure cap if the rubber gasket is damaged.

Cooling system pressure test

1. Remove the radiator cap. Add coolant if necessary.
2. Install the radiator cap tester to the radiator.
3. Warm up the engine to the normal operating temperature.
4. Stop the engine. Pump up the system to **100 kPa (14 lb/in²)** and observe the gauge for about one minute. If the pressure drops, visually inspect all hoses and fittings for an external leak.

Caution

To remove the radiator pressure cap when the coolant temperature is high or boiling, place a cloth on the pressure cap and turn counter clockwise one step. Keep it in this position until all pressure is released. Then turn the cap further until it can be removed.

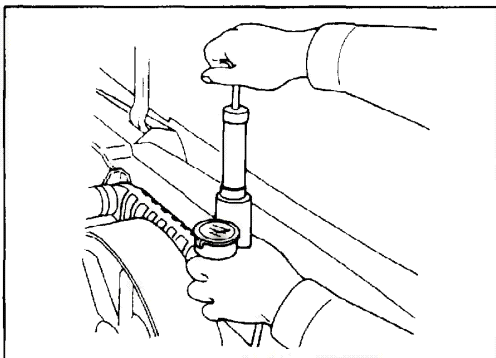

57U030-011

3 WATER PUMP

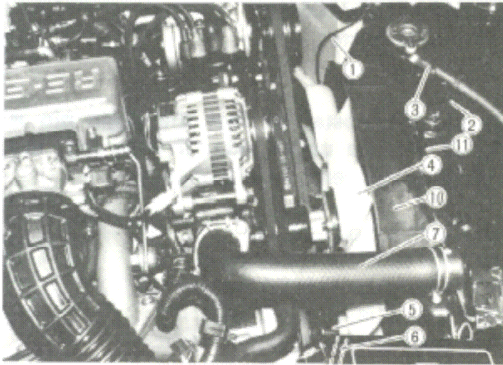

57U030-012

REMOVING RADIATOR

Remove or disconnect the following parts.

1. No. 2 water temperature switch connector
2. Coolant level sensor lead
3. Water hose for reservoir
4. Cooling fan and fan drive assembly
5. Radiator lower hose (drain the cooling system.)
6. Heater hose
7. Radiator upper hose
8. Oil hoses (for automatic transmission)
9. Radiator shroud
10. Radiator

INSTALLING RADIATOR

Follow the removal procedures in the reverse order. Fill the cooling system with a mixture of 50% clean soft water (demineralized water) and 50% anti-freeze solution (ethylene glycol base for aluminum engine).

47U030-506

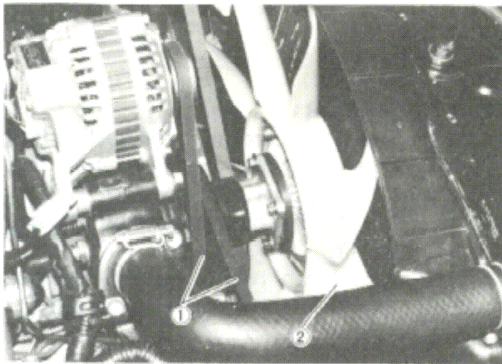

47U030-013

WATER PUMP

CHECKING WATER PUMP

1. Remove both the alternator belt and the air pump belt.
2. Remove the cooling fan.
3. Check the water pump for cracks, abnormal bearing noise, coolant leaks, or any other visible damage.

If any of these conditions exists, the pump should be repaired or replaced.

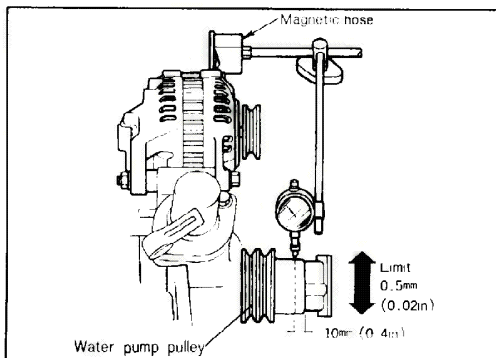

47U030-014

4. Fit a dial indicator to the alternator bracket so that it contacts the water pump pulley as shown.
5. Move the pulley up and down by hand. (Be careful not to turn the pulley, otherwise a false reading may be given.)
6. If the indicator reading is in excess of the specified limit shown below, the pump should be repaired or replaced.

**Water pump shaft play should not exceed:
0.5 mm (0.02 in)**

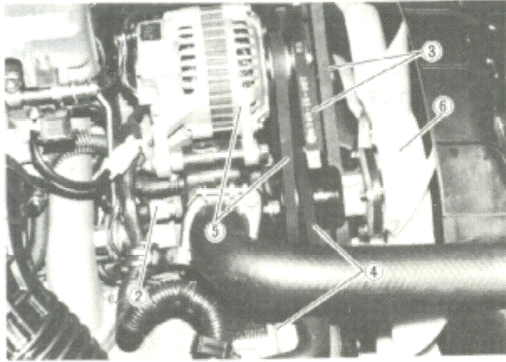

47U030-015

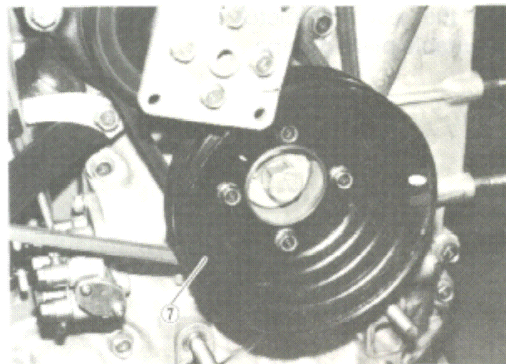

47U030-016

REMOVING WATER PUMP

1. Remove the air cleaner (12A).
2. Disconnect the connector from the water temperature switch (12A) or water thermo sensor (13B).
3. Disengage the drive belt for air conditioning compressor and power steering pump (if equipped).
4. Remove the air pump and disengage the drive belt.
5. Remove the alternator and disengage the drive belt.
6. Remove the cooling fan and fan drive assembly.
7. Remove the pulley for air conditioning compressor.
8. Disconnect the radiator lower hose (drain the cooling system).
9. Disconnect the radiator upper hose.
10. Remove the water pump.

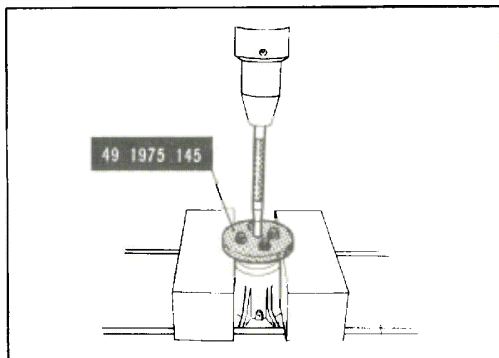

47U030-017

DISASSEMBLING WATER PUMP

1. Attach the **adapter** (49 1975 145) on to the pulley boss and tighten the four bolts firmly.
2. Support the water pump pulley adapter on the press. Press the water pump shaft slowly and remove the pulley boss.

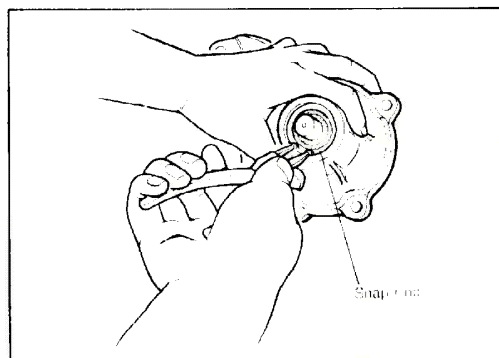

47U030-018

3. Remove the snap ring.

3 WATER PUMP

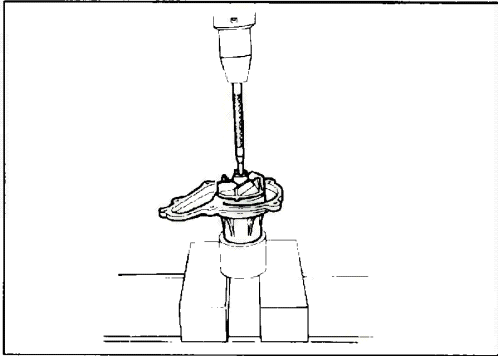

47U030-019

4. Support the pump body and apply pressure to the rear end of the shaft to press the shaft bearing out through the front of the pump body.
5. Remove the impeller.

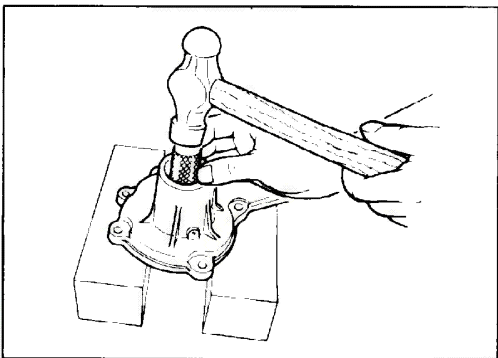

47U030-020

6. Remove the seal (complete) by lightly tapping with a suitable piece of pipe.

INSPECTING WATER PUMP

1. Inspect the bearing for roughness or excessive end play. Remove any rust or scale from the bearing shaft with an emery cloth.
2. Inspect the seat of the seal on the impeller for pit marks or scoring. If the seat of the seal is scored or pitted, the impeller should be replaced.
3. Inspect the water pump body and the impeller for cracks or wear. Replace if necessary.

47U030-021

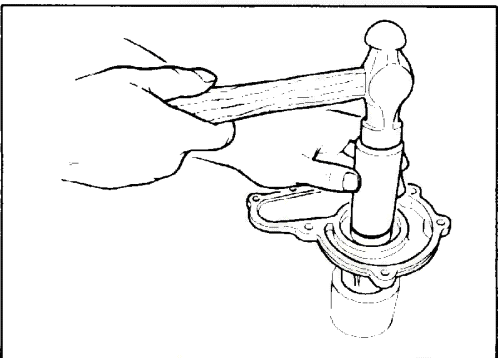

47U030-022

ASSEMBLING WATER PUMP

1. Press in the seal (complete) by using a suitable piece of pipe.

Cautions

- a) When pressing in the water seal, be careful that the seal is straight, and that the surface doesn't become damaged.
- b) After pressing in the water seal, press the seal lip with a finger to be sure it moves smoothly.

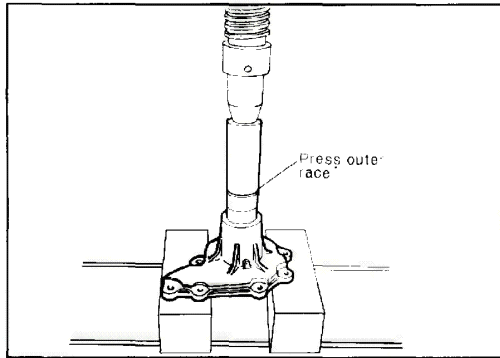

57U030-023

2. Coat the water seal lip with coolant.
3. Press in the shaft bearing by using a suitable piece of pipe.

Caution

After pressing in the shaft and bearing, check to be sure rotation is smooth.

4. Attach the snap ring.

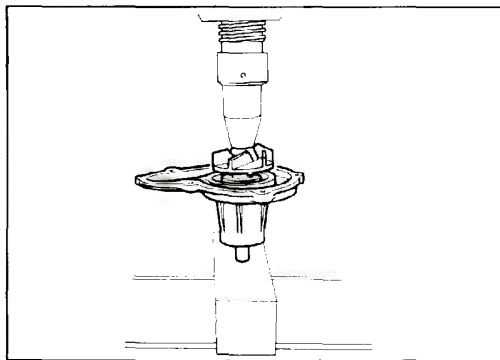

47U030-024

5. Press in the impeller.
6. Press in the puller boss.

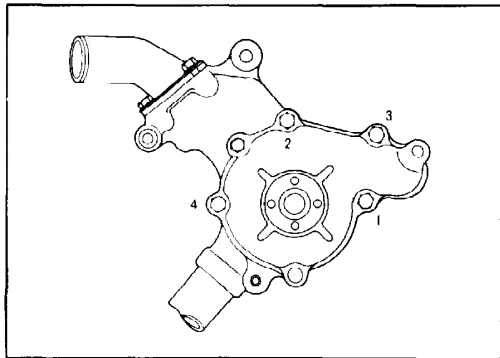

47U030-025

INSTALLING WATER PUMP

1. Attach the gasket to the surface of the side housing which contacts the water pump.
2. Attach shims (for height adjustment) to the stud bolts indicated by 2 and 4 in the figure.
3. Install the water pump and tighten by evenly applying torque in the numbered order indicated in the figure.

Tightening torque: 18 ~ 27 N·m (13 ~ 20 ft·lb)

4. Connect the radiator upper hose.
5. Connect the radiator lower hose.

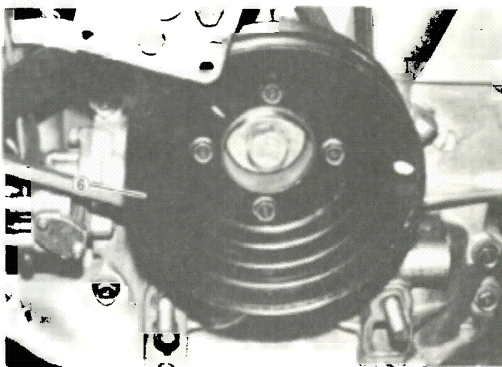

57U030-026

6. Install the pulley for the power steering pump and the air conditioning compressor (if so equipped).

3 WATER PUMP

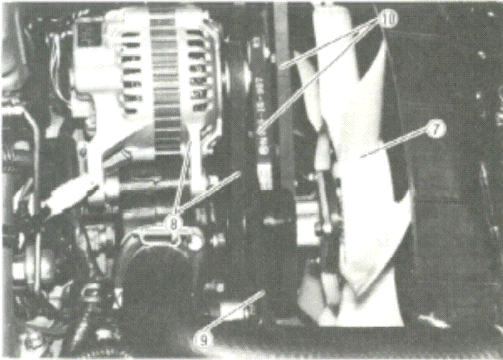

47U030-027

7. Install the cooling fan and fan drive assembly.
8. Engage the alternator drive belt and install the alternator.
9. Engage the air pump drive belt and install the air pump.
10. Engage the drive belt for air conditioning compressor and power steering pump (if equipped).
11. Adjust the tension of each belt to 10 kg (22 lb.) when pressed at the places shown in the figure.

Standard belt deflection

Alternator drive belt	13 ~ 17 mm (0.51 ~ 0.67 in)
Air pump drive belt	11 ~ 13 mm (0.43 ~ 0.51 in)
Air conditioning compressor drive belt	10 ~ 12 mm (0.40 ~ 0.47 in)
Power steering drive belt	10 ~ 12 mm (0.40 ~ 0.47 in)

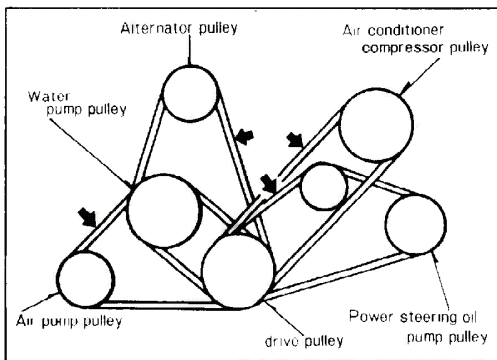

47U030-028

12. Connect the connector to the water temperature switch (12A) or water thermo sensor (13B).
13. Install the air cleaner (12A).
14. Fill the cooling system with the specified coolant.